

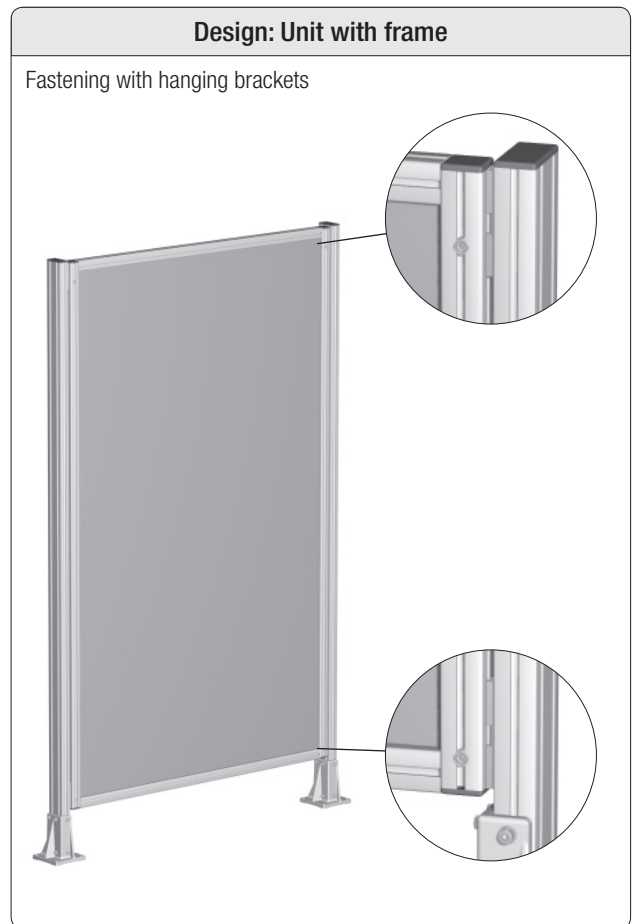

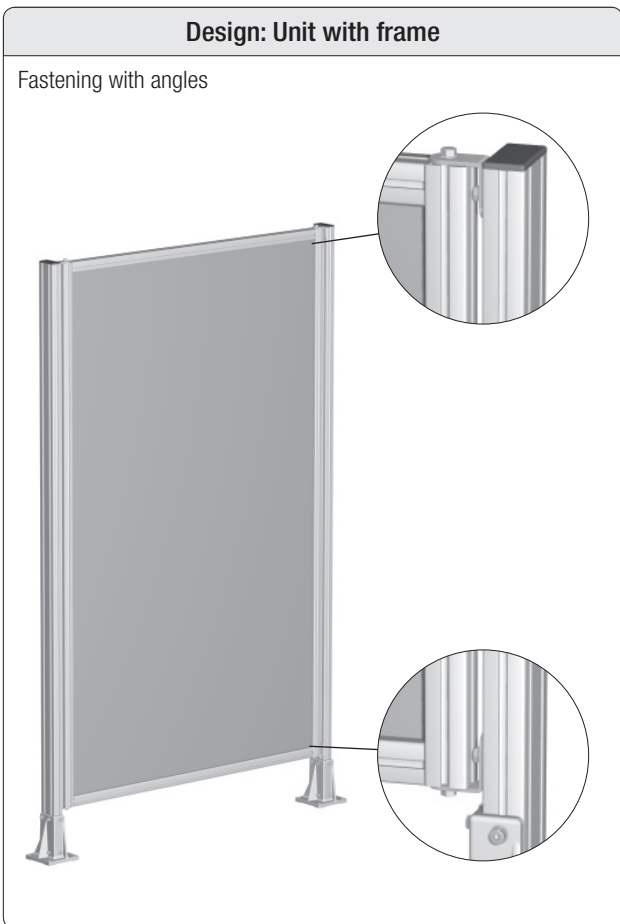

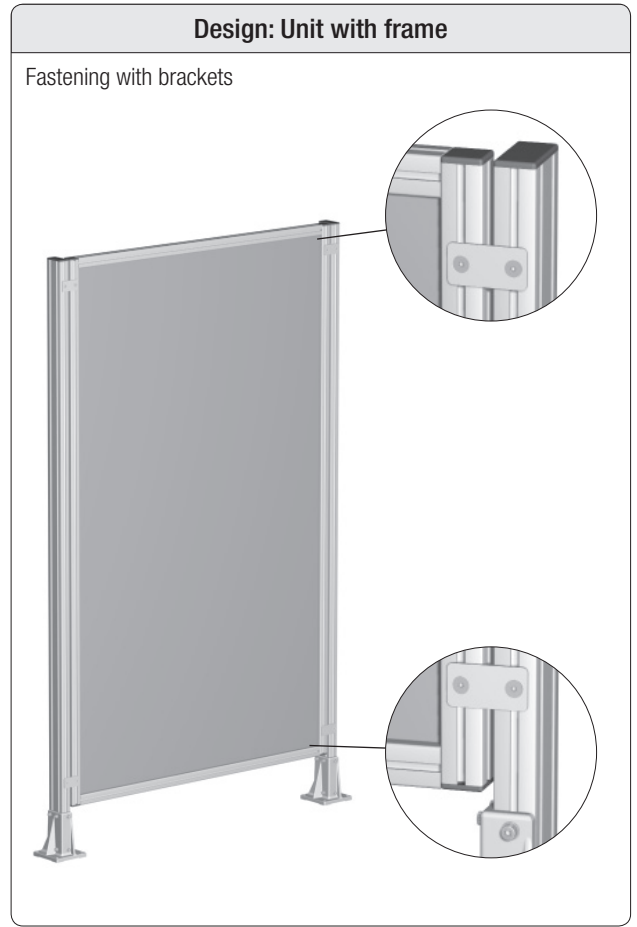
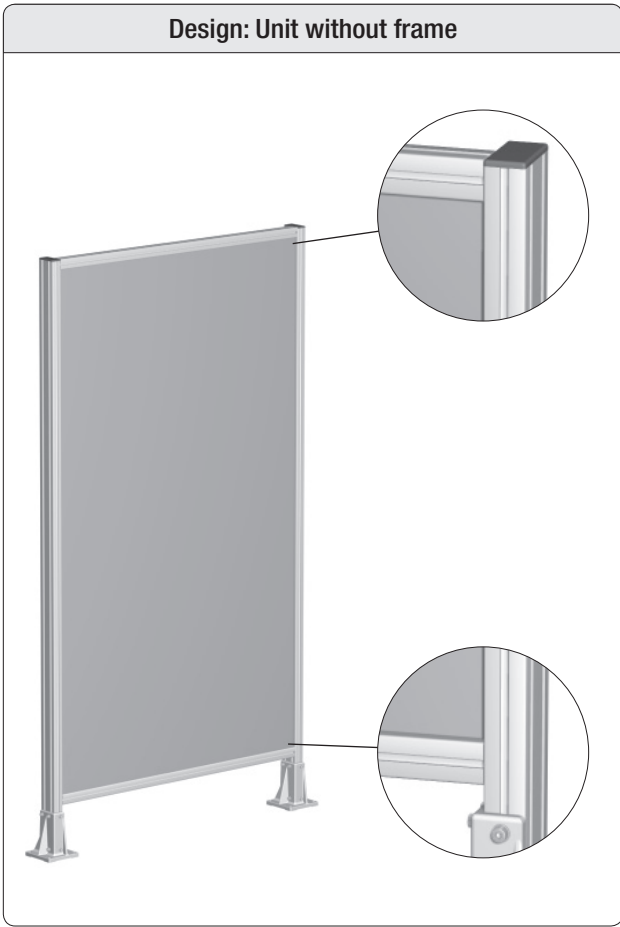

## » Safety barriers

	Page
<b>Frame variations .....</b>	<b>1</b>
Unit without frame .....	1
Unit with frame .....	1
<b>Mounting of panel elements .....</b>	<b>2</b>
<b>Classifications.....</b>	<b>3</b>
<b>Standard unit dimensions .....</b>	<b>4</b>
<b>Safety barriers: Designs.....</b>	<b>5</b>
Safety barrier unit without frame .....	5
Safety barrier unit with frame .....	6
Single hinged door.....	7
Double hinged door.....	8
Sliding door.....	9
<b>Profiles.....</b>	<b>10</b>
Profile group 40, E3-slot, P (plain).....	10
Profile group 40, E3-slot .....	10
Profile group 45, E4-slot, P (plain).....	10
Panel profiles 30, F-slot, P (plain) .....	11
Panel profiles 40, E3-slot, P (plain) .....	12
Panel profiles 50, E4-slot, P (plain) .....	13
Wire net profiles 30, F-slot, P (plain) .....	14
Wire net profiles 40, F / E3-slot, P (plain) .....	14
<b>Standards for guards .....</b>	<b>15</b>
<b>Static load .....</b>	<b>16</b>
<b>Dynamic load .....</b>	<b>17</b>
Test layout.....	17
Safety barrier unit without frame.....	18
Safety barrier unit with frame .....	19

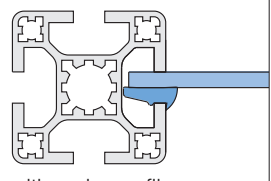
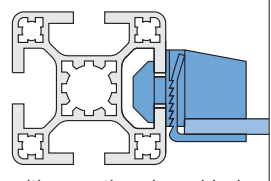
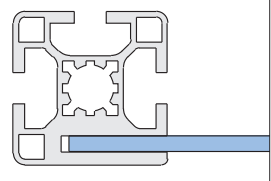
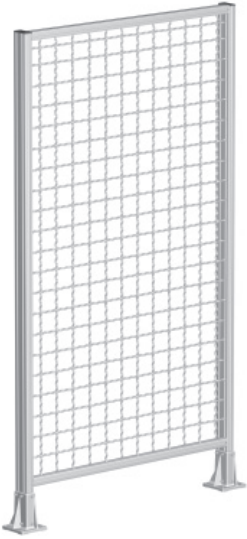
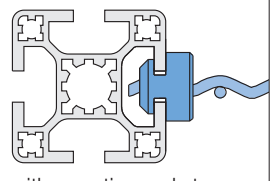
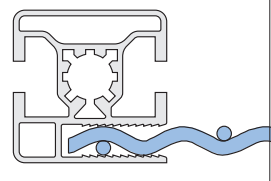
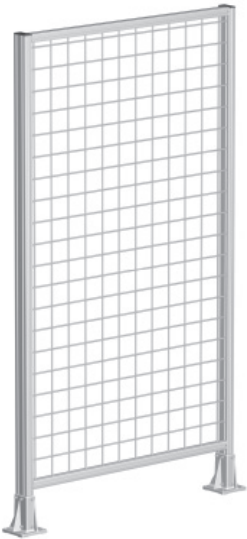
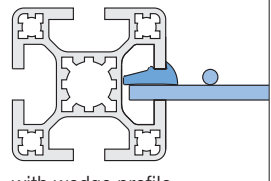
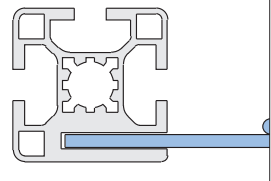
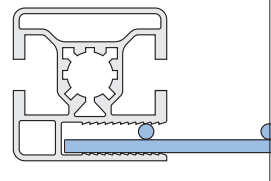

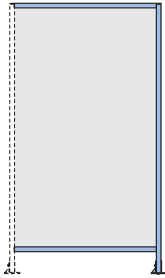
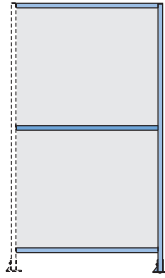
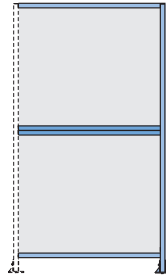
Panel element	Frame profile		
	Standard	Panel	Wire net
<b>Polycarbonate</b> 	 with wedge profile   with mounting clamp blocks		
<b>Wire net</b> 	 with mounting sockets		
<b>Welded wire net (steel)</b> 	 with wedge profile		

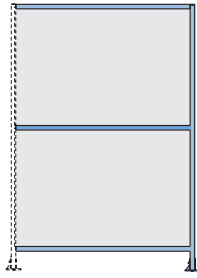
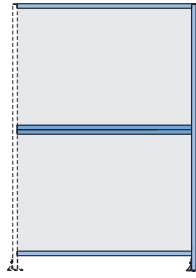
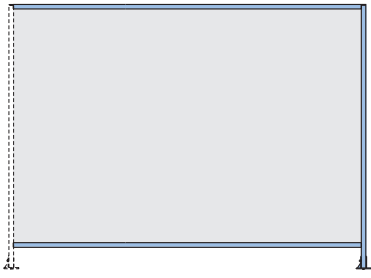
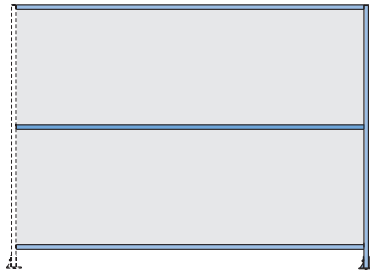
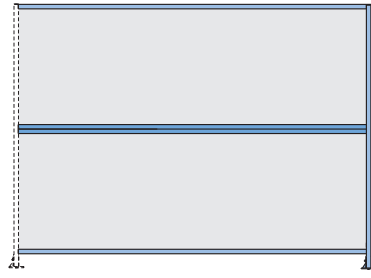
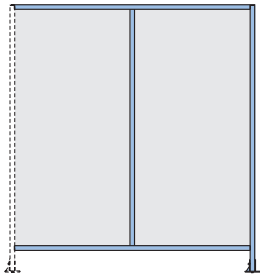
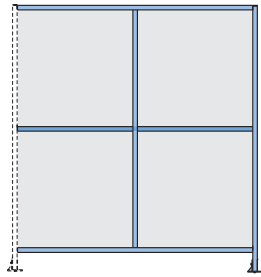
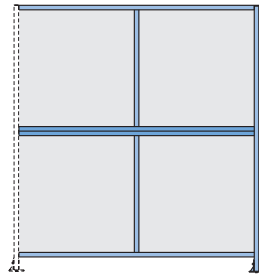
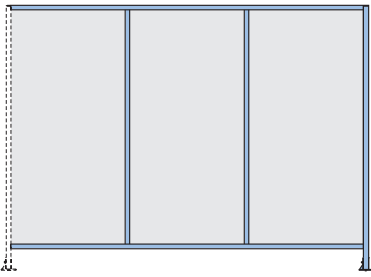
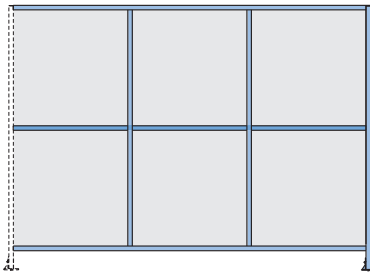
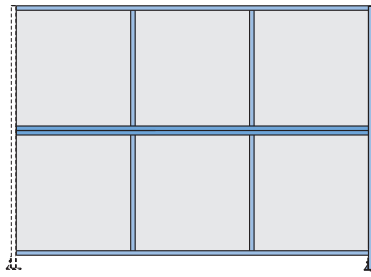
without cross strut	with cross strut	divided
		
		
		
		
		

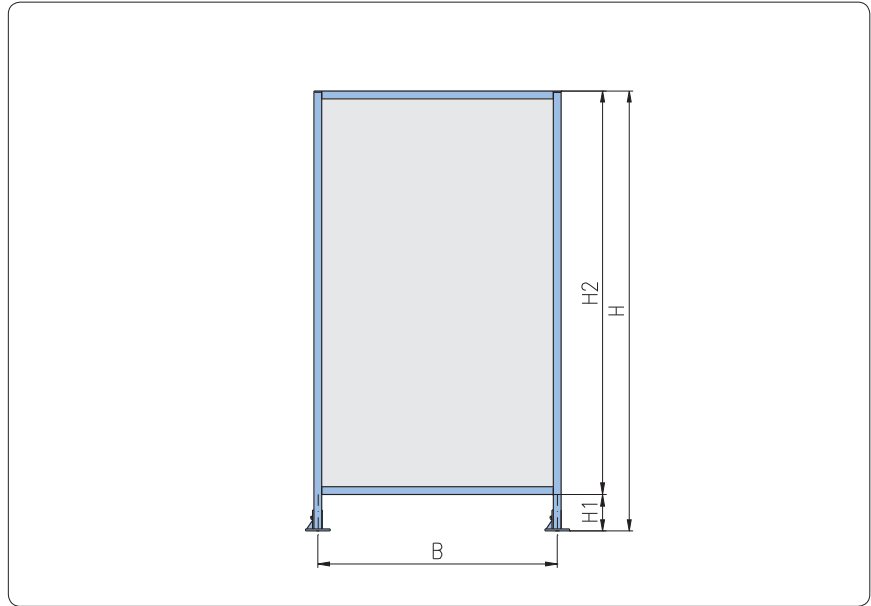
**Single panel unit**

H	H1		B				
1,800	200	300	250	500	750	1,000	1,250
2,000							
2,200							
2,300							
2,300							

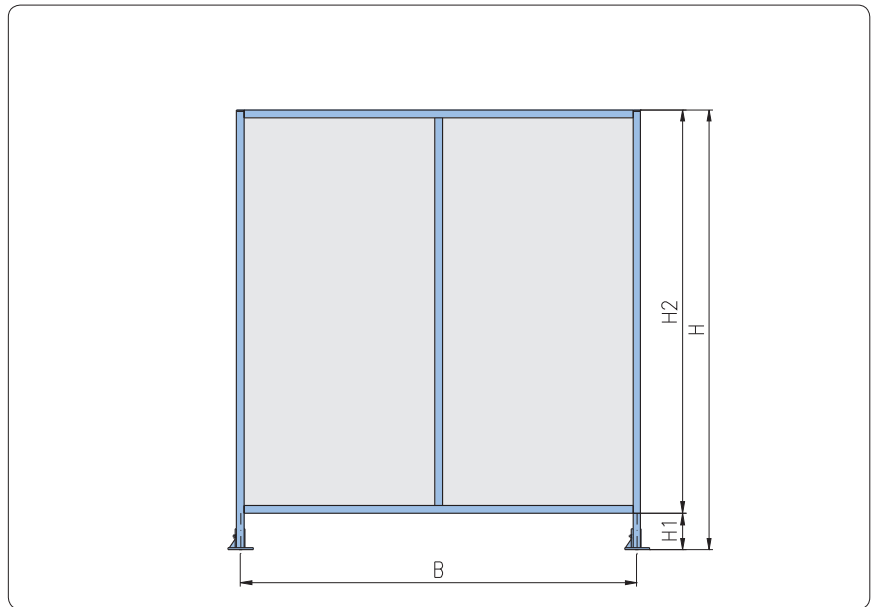
**Double panel unit**

H	H1		B			
1,800	200	300	1,500	1,750	2,000	2,500
2,000						
2,200						
2,300						
2,300						

Safety barrier unit:  
without frame



Unit			Post														
Panel element	Frame profile			Mounting			Post profile										
	Standard	Panel	Wire net	of panel element			Standard					Panel					
	40×40, 4E	45×45, 4E	40×40	30×30	40×40	wedge profile	m. clamp blocks	mounting sockets	40×40	40×80	80×80	80×80, corner	45×45	45×90	60×80 5E	60×80 6E	
Polycarbonate transparent	4 mm	•				•	•		•	•	•	•					
			•				•	•					•	•			
				•												•	•
Wire net	alu	3×20×20 mm	•						•	•	•	•					
				•									•	•			
		4×30×30 mm	•							•	•	•	•				
	steel	4×30×30 mm, 4×40×40 mm	•							•	•	•	•				
				•										•	•		
		3×25×25 mm	•					•			•	•	•	•			
Welded wire net (steel)	3×25×25 mm		•											•	•		
			•											•	•		
	4×40×40 mm	•					•			•	•	•	•				
Welding protecting glass	4 mm		•						•	•	•	•					
				•									•	•			
					•											•	•

**Safety barrier unit:  
with frame**

Unit			Post													Fastening				
Panel element	Frame profile			Mounting			Post profile						of element							
	Standard	Panel	Wire net	of panel element			Standard			Panel										
	40×40, 4E	45×45, 4E	40×40	30×30	40×40	wedge profile	m. clamp blocks	mounting sockets	40×40	40×80	80×80	80×80, corner	45×45	45×90	60×80 5E	60×80 6E	hanging bracket	angle	bracket	
Polycarbonate transparent	4 mm					•	•		•	•	•	•					•	•	•	
		•				•	•					•	•				•	•	•	
			•												•	•	•	•	•	
Wire net	alu	3×20×20 mm	•					•	•	•	•						•	•	•	
			•									•	•				•	•	•	
		4×30×30 mm	•						•	•	•	•						•	•	•
	steel					•	•			•	•	•	•	•				•	•	
		4×30×30 mm, 4×40×40 mm	•						•	•	•	•						•	•	•
			•										•	•				•	•	•
					•	•				•	•	•	•	•				•	•	
Welded wire net (steel)	3×25×25 mm	•				•			•	•	•	•					•	•	•	
		•				•						•	•				•	•	•	
	4×40×40 mm	•				•			•	•	•	•					•	•	•	
		•				•						•	•				•	•	•	
Welding protecting glass	green-brown	4 mm	•				•		•	•	•	•					•	•	•	
			•				•					•	•				•	•	•	
				•											•	•		•	•	•



**Single hinged door**

Unit			Post														
Panel element	Frame profile			Mounting			Post profile										
	Standard	Panel	Wire net	of panel element			Standard					Panel					
	40×40, 4E	45×45, 4E	40×40	30×30	40×40	wedge profile	m. clamp blocks	mounting sockets	40×40	40×80	80×80	80×80, corner	45×45	45×90	60×80 5E	60×80 6E	
Polycarbonate transparent	4 mm	•				•	•		•	•	•	•					
			•				•	•					•	•			
				•												•	•
Wire net	alu	3×20×20 mm	•						•	•	•	•					
				•									•	•			
		4×30×30 mm	•							•	•	•	•				
	steel	4×30×30 mm, 4×40×40 mm				•	•			•	•	•	•				
			•							•	•	•	•				
					•	•				•	•	•	•				
										•	•	•	•				
Welded wire net (steel)	3×25×25 mm	•				•			•	•	•	•					
			•				•						•	•			
	4×40×40 mm	•				•			•	•	•	•					
			•				•							•	•		
Welding protecting glass	4 mm	•				•			•	•	•	•					
			•				•							•	•		
				•												•	•

**Double hinged door**

Unit			Post													Locking			
			Frame profile			Mounting			Post profile						Panel				
Panel element			Standard	Pa- nel	Wire net	of panel element			Standard						Panel				
			40×40, 4E	45×45, 4E	40×40	30×30	40×40	wedge profile	m. clamp blocks	mounting sockets	40×40	40×80	80×80	80×80, corner	45×45	45×90	60×80 5E	60×80 6E	top
Polycarbonate trans- parent	4 mm	•					•	•		•	•	•	•					•	•
			•				•	•						•	•			•	•
				•												•	•	•	•
Wire net	alu	3×20×20 mm	•						•	•	•	•						•	•
				•						•				•	•			•	•
		4×30×30 mm	•						•	•	•	•						•	•
			•						•				•	•				•	•
					•	•			•	•	•	•	•	•				•	•
	steel	4×30×30 mm, 4×40×40 mm	•						•	•	•	•						•	•
								•					•	•			•	•	
Welded wire net (steel)	3×25×25 mm	•					•		•	•	•	•						•	•
			•				•						•	•			•	•	
	4×40×40 mm	•					•		•	•	•	•					•	•	
					•	•			•				•	•			•	•	
Welding protecting glass	4 mm	•					•		•	•	•	•						•	•
			•				•						•	•			•	•	
				•												•	•	•	•

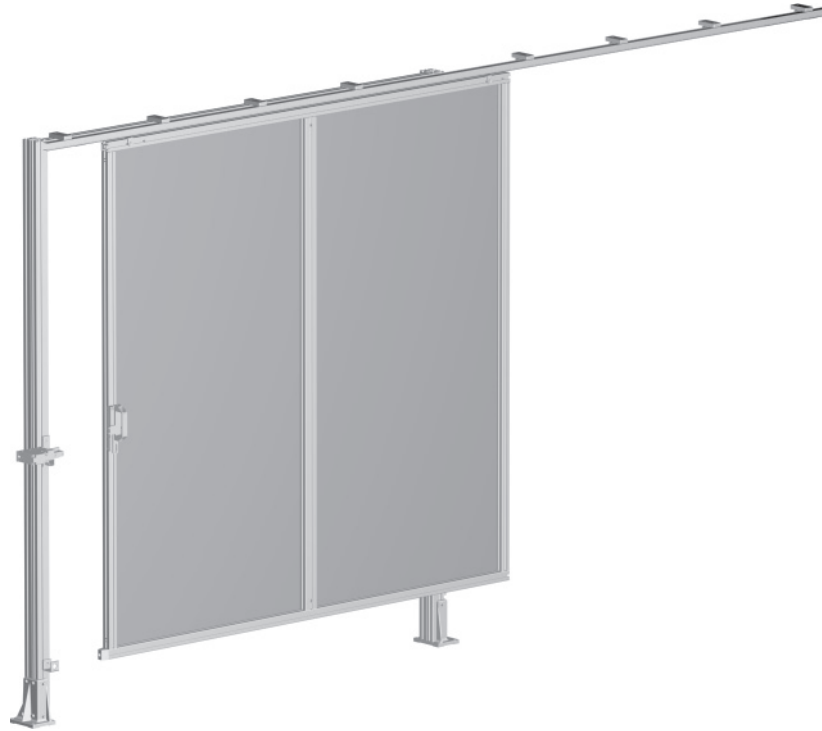
**Sliding door**

Unit			Post														
Panel element	Frame profile			Mounting			Post profile										
	Standard	Pa- nel	Wire net	of panel element			Standard					Panel					
	40×40, 4E	45×45, 4E	40×40	30×30	40×40	wedge profile	m. clamp blocks	mounting sockets	40×40	40×80	80×80	80×80, corner	45×45	45×90	60×80 5E	60×80 6E	
Polycarbonate trans- parent	4 mm	•				•	•		•	•	•	•					
			•				•	•					•	•			
Wire net	alu	3×20×20 mm						•	•	•	•						
				•					•				•	•			
		4×30×30 mm	•						•	•	•	•					
	steel	4×30×30 mm, 4×40×40 mm			•	•			•	•	•	•	•	•			
				•					•					•	•		
		3×25×25 mm	•				•			•	•	•	•	•	•		
Welded wire net (steel)	3×25×25 mm					•			•	•	•	•		•	•		
			•										•	•			
	4×40×40 mm	•				•			•	•	•	•					
Welding protecting glass	4 mm					•			•	•	•	•					
			•										•	•			
				•	•	•				•	•	•	•			•	•

light				
Description	Profile 40×40, 4E, LP	Profile 40×80, 6E, LP	Profile 80×80, 8E, LP	
bar, 6 m	1.11.040040.43LP.60	1.11.040080.64LP.60	1.11.080080.83LP.60	
packing unit (number)	1.11.040040.43LP.61 (8)	1.11.040080.64LP.61 (4)	1.11.080080.83LP.61 (2)	
moment of inertia cm <sup>4</sup>	$I_x = 9.9$ $I_y = 9.9$	$I_x = 62.7$ $I_y = 17.7$	$I_x = 114.0$ $I_y = 114.0$	
moment of resistance cm <sup>3</sup>	$W_x = 4.9$ $W_y = 4.9$	$W_x = 15.6$ $W_y = 8.8$	$W_x = 28.4$ $W_y = 28.4$	
weight kg/m	G = 1.5	G = 2.5	G = 4.1	

## Profile group 40 mm, E3-slot

## Profile group 45 mm, E4-slot, P (plain)

heavy		light		
Description	Profile 80×80, 8E, angle, S	Description	Profile 45×45, 4E, LP	Profile 45×90, 6E, LP
bar, 6 m	1.11.080080.87S.60	bar, 6 m	1.11.045045.43LP.60	1.11.045090.64LP.60
packing unit (number)	1.11.080080.87S.61 (2)	packing unit (number)	1.11.045045.43LP.61 (8)	1.11.045090.64LP.61 (4)
moment of inertia cm <sup>4</sup>	$I_x = 120.0$ $I_y = 120.0$	Trägheitsmoment cm <sup>4</sup>	$I_x = 13.5$ $I_y = 13.5$	$I_x = 98.0$ $I_y = 27.5$
moment of resistance cm <sup>3</sup>	$W_x = 23.8$ $W_y = 23.8$	Widerstandsmoment cm <sup>3</sup>	$W_x = 6.0$ $W_y = 6.0$	$W_x = 21.8$ $W_y = 12.2$
weight kg/m	G = 6.3	Gewicht kg/m	G = 1.9	G = 3.3

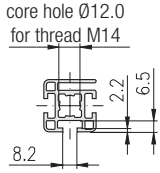
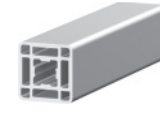
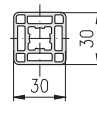
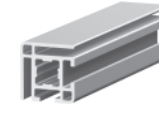
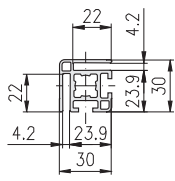
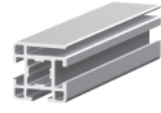
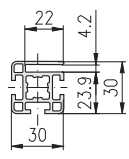
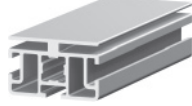
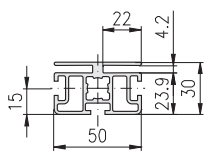
light				
	 	 	 	 
Description	Panel profile 30×30, OF, LP	Panel profile 30×30, 2F, corner, LP 4	Panel profile 30×30, 3F, LP 4	Panel profile 30×50, 3F, LP 4
bar, 6 m	1.14.030030.03LP0.60	1.14.030030.22LP4.60	1.14.030030.33LP4.60	1.14.030050.34LP4.60
packing unit (number)	1.14.030030.03LP0.61(10)	1.14.030030.22LP4.61(10)	1.14.030030.33LP4.61(10)	1.14.030050.34LP4.61 (6)
moment of inertia cm <sup>4</sup>	$I_x = 3.8$ $I_y = 3.8$	$I_x = 3.3$ $I_y = 3.3$	$I_x = 3.3$ $I_y = 2.8$	$I_x = 5.5$ $I_y = 11.8$
moment of resistance cm <sup>3</sup>	$W_x = 2.4$ $W_y = 2.4$	$W_x = 2.2$ $W_y = 2.2$	$W_x = 2.2$ $W_y = 1.8$	$W_x = 3.6$ $W_y = 4.8$
weight kg/m	$G = 1.1$	$G = 1.0$	$G = 0.9$	$G = 1.5$

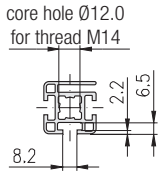
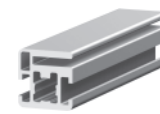
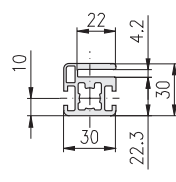
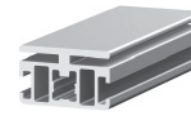
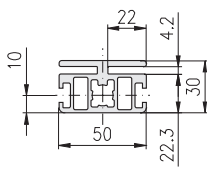
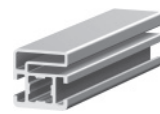
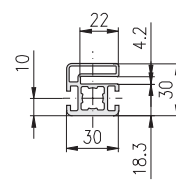
light				
	 	 	 	
Description	Panel profile 30×30, 2F, LP 5	Panel profile 30×50, 2F, LP 5		Panel profile 30×30, 2F, LP 6
bar, 6 m	1.14.030030.23LP5.60	1.14.030050.24LP5.60		1.14.030030.23LP6.60
packing unit (number)	1.14.030030.23LP5.61(10)	1.14.030050.24LP5.61(10)		1.14.030030.23LP6.61 (6)
moment of inertia cm <sup>4</sup>	$I_x = 4.3$ $I_y = 3.3$	$I_x = 7.0$ $I_y = 14.7$		$I_x = 3.6$ $I_y = 2.8$
moment of resistance cm <sup>3</sup>	$W_x = 2.8$ $W_y = 2.2$	$W_x = 4.7$ $W_y = 5.9$		$W_x = 2.4$ $W_y = 1.9$
weight kg/m	$G = 1.2$	$G = 1.9$		$G = 1.0$

<p>light</p>	 	 	 	 	
	Description	Panel profile 40×40, 2E, corner, LP 4	Panel profile 40×40, 3E, LP 4	Panel profile 40×60, 3E, LP 4	Panel profile 60×80, 5E, LP 4
	bar, 6 m	1.14.040040.22LP4.60	1.14.040040.33LP4.60	1.14.040060.34LP4.60	1.14.060080.54LP4.60
	packing unit (number)	1.14.040040.22LP4.61 (8)	1.14.040040.33LP4.61 (8)	1.14.040060.34LP4.61 (8)	1.14.060080.54LP4.61 (4)
	moment of inertia cm <sup>4</sup> moment of resistance cm <sup>3</sup> weight kg/m	$I_x = 10.3$ $I_y = 10.3$ $W_x = 5.2$ $W_y = 5.2$ G = 1.8	$I_x = 10.2$ $I_y = 8.7$ $W_x = 5.1$ $W_y = 4.3$ G = 1.65	$I_x = 14.8$ $I_y = 26.3$ $W_x = 7.4$ $W_y = 8.8$ G = 2.4	$I_x = 100.4$ $I_y = 50.4$ $W_x = 25.1$ $W_y = 16.8$ G = 3.8

<p>light</p>	<b>Profile for door stop</b>				
	Description	Panel profile 60×80, 6E, LP 4	Profile 20×30, 1F, LP	Assembly drawing	Assembly drawing
	bar, 6 m	1.14.060080.64LP4.60	1.11.020030.14LP.60		
	packing unit (number)	1.14.060080.64LP4.61 (4)	1.11.020030.14LP.61 (10)		
moment of inertia cm <sup>4</sup> moment of resistance cm <sup>3</sup> weight kg/m	$I_x = 88.1$ $I_y = 52.0$ $W_x = 22.1$ $W_y = 17.3$ G = 3.7	$I_x = 2.2$ $I_y = 1.4$ $W_x = 1.5$ $W_y = 1.4$ G = 0.7	$I_x = 113.0$ $I_y = 64.0$ $W_x = 28.5$ $W_y = 21.3$ G = 4.5	$I_x = 89.2$ $I_y = 53.3$ $W_x = 22.3$ $W_y = 17.7$ G = 4.4	

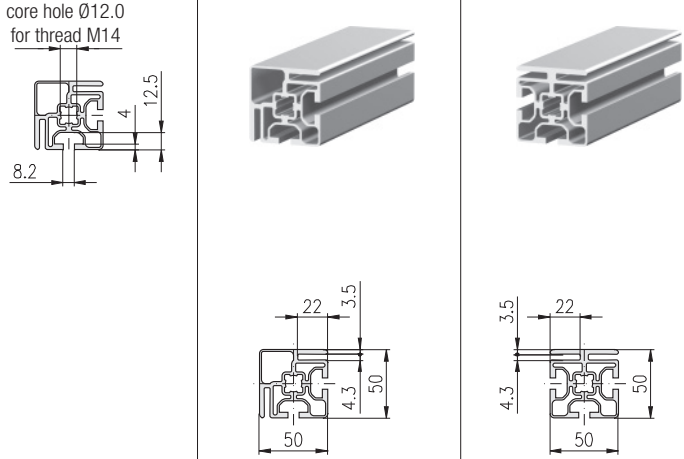
<div style="border: 1px solid black; border-radius: 10px; padding: 2px; display: inline-block;">light</div>				
Description	Panel profile 50×50, 2E, corner, LP 4	Panel profile 50×50, 3E, LP 4		
bar, 6 m	1.14.050050.22LP4.60	1.14.050050.39LP4.60		
packing unit (number)	1.14.050050.22LP4.61 (6)	1.14.050050.39LP4.61 (6)		
moment of inertia cm <sup>4</sup>	$I_x = 19.4$ $I_y = 19.4$	$I_x = 24.1$ $I_y = 21.4$		
moment of resistance cm <sup>3</sup>	$W_x = 7.6$ $W_y = 7.6$	$W_x = 8.0$ $W_y = 8.5$		
weight kg/m	G = 2.4	G = 2.7		

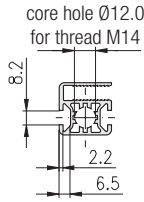
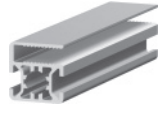
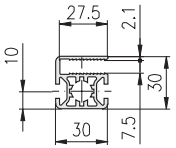
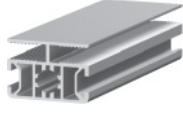
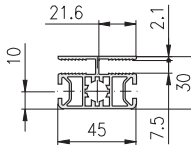
light				
	 	 		
Description	Wire net profile 30×30, 2F, LP 7.5	Wire net profile 30×45, 2F, LP 7.5		
bar, 6 m	1.15.030030.23LP7.60	1.15.030045.24LP7.60		
packing unit (number)	1.15.030030.23LP7.61(10)	1.15.030045.24LP7.61 (8)		
moment of inertia cm <sup>4</sup>	$I_x = 2.6$ $I_y = 3.2$	$I_x = 4.3$ $I_y = 7.4$		
moment of resistance cm <sup>3</sup>	$W_x = 1.7$ $W_y = 2.1$	$W_x = 2.9$ $W_y = 3.3$		
weight kg/m	$G = 0.86$	$G = 1.15$		

**Wire net profiles 40, F / E3-slot, P (plain)**

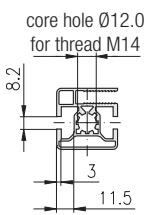
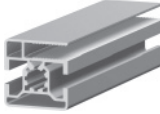
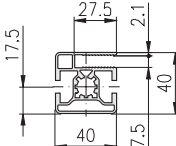
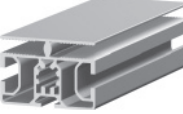
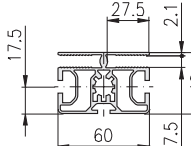
light				
	 	 		
Description	Wire net profile 40×40, 2E, LP 7.5	Wire net profile 40×60, 2E, 1F, LP 7.5		
bar, 6 m	1.15.040040.23LP7.60	1.15.040060.34LP7.60		
packing unit (number)	1.15.040040.23LP7.61 (8)	1.15.040060.34LP7.61 (8)		
moment of inertia cm <sup>4</sup>	$I_x = 7.5$ $I_y = 8.2$	$I_x = 12.2$ $I_y = 22.5$		
moment of resistance cm <sup>3</sup>	$W_x = 3.8$ $W_y = 4.1$	$W_x = 6.1$ $W_y = 7.5$		
weight kg/m	$G = 1.35$	$G = 1.97$		



## Standards for guards

Besides the essential safety requirements of the **machinery directive 98/37/EC** and the **DIN EN ISO 12100 part 1+2 - safety of machinery** - the following standards (Type B Standards) apply when designing guards, e.g. safety barriers.

### EN 294 - Safety distances to prevent danger zones being reached by the upper limbs

The safety distances depend on the height and size of the opening in the safety guard. A mesh size of 40x40 mm requires a safety distance of 200 mm. The following figures show the safety distance profiles in accordance with **EN 294** and **EN 811** for two different heights of the safety barrier. The safety distance layout of a concrete safety barrier always requires a risk assesment according to **DIN EN ISO 12100**.

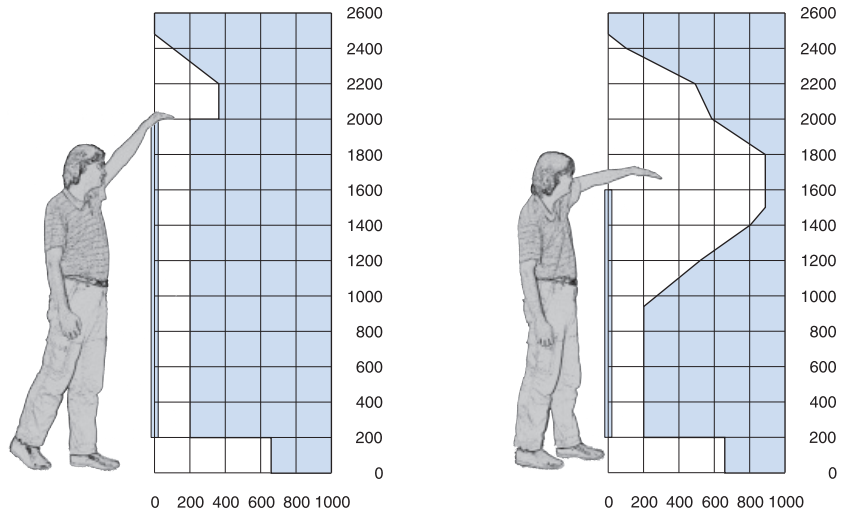

### EN 811 - Safety distances to prevent danger zones being reached by the lower limbs

When the following preconditions are fulfilled EN 811 allows greater openings than EN 294:

- the related persons are at least 14 years old
- it is justifiable predictable that for reaching the hazardous area only the lower limbs are used.

In accordance with EN 811 openings greater than 180 mm (slit shaped) or 240 mm (square / circular type) allow access to the whole body. Besides this an extended rule exists for ground clearance, where access from upright position is assumed. Ground clearance of 200 mm results in a safety distance of 665 mm for the feet area, as it is shown in the following figures.

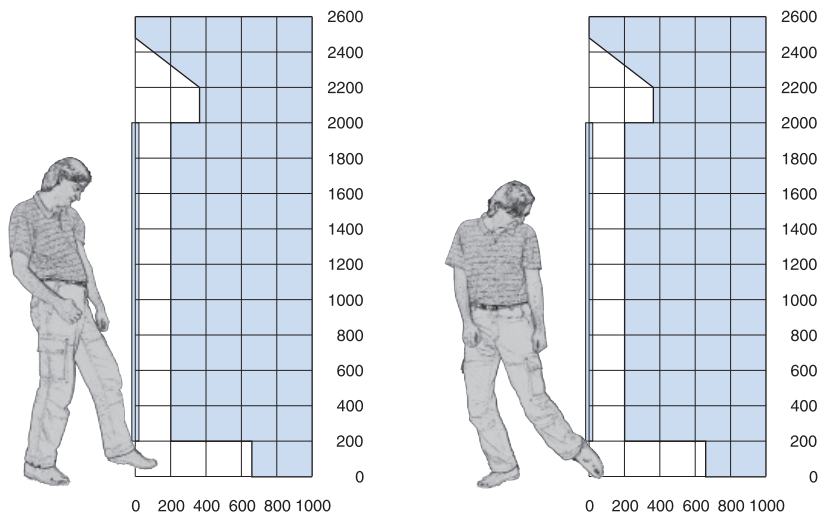

### DIN EN 953 - Guards

General requirements for the design and construction of fixed and movable guards

### Note

If for a certain machinery a special machinery safety standard (Type C Standard) is provided, the specifications of this Type C Standard take precedence.

### Examples of Type C Standards:

- DIN EN 619 - Continuous handling equipment and systems
  - DIN EN 693 - Hydraulic presses
  - DIN EN 775 - Industrial robots.
- Recommendations for safety

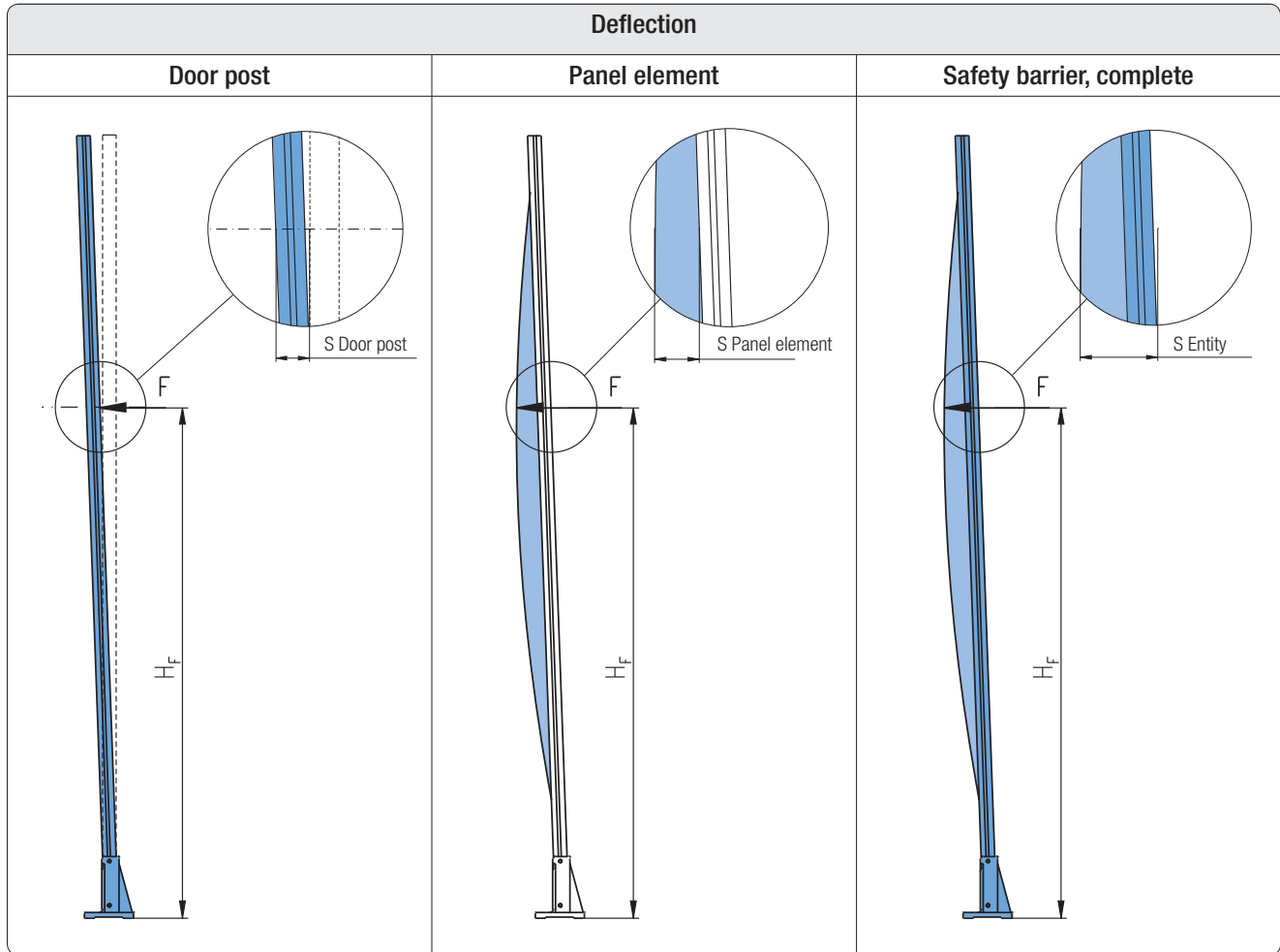

**Safety barrier element: without frame**  
**Panel element: Polycarbonate 4 mm**

F in N							
100	150	300	450	600	1,000	1,500	2,000

Standard profile	Door post	$H_f$		S in mm						
	Profile 40×80, 6E, LP	1,000	1.0	2.0	3.0	5.0	6.0	10.0	15.0	20.0
	1,500	3.5	5.0	10.0	15.0	20.0	35.0	62.0	95.0	
Safety barrier, complete		$H_f = 1,500$		S in mm						
Profile 40×80, 6E, LP	Door post	2.0	2.5	5.0	8.0	10.0	17.5	31.0	48.0	
Profile 40×40, 4E, LP	Panel element	30.0	38.0	49.0	59.0	65.0	82.0	98.0	115.0	
	Entity	32.0	40.5	54.0	67.0	75.0	99.0	129.0	163.0	

Panel profile	Door post	$H_f$		S in mm						
	Profile 60×80, 6E, Panel, LP	1,000	1.0	1.5	2.0	3.0	5.0	8.0	12.0	16.0
	1,500	2.6	3.5	7.0	10.0	14.0	26.0	40.0	52.0	
Safety barrier, complete		$H_f = 1,500$		S in mm						
Profile 60×80, 6E, Panel, LP	Door post	1.5	2.0	3.5	5.0	7.0	13.0	20.0	26.0	
Profile 40×80, 3E, Panel, LP	Panel element	35.0	39.0	48.0	54.0	60.0	73.0	84.0	94.0	
	Entity	36.5	41.0	51.5	59.0	67.0	86.0	104.0	120.0	

## Test layout

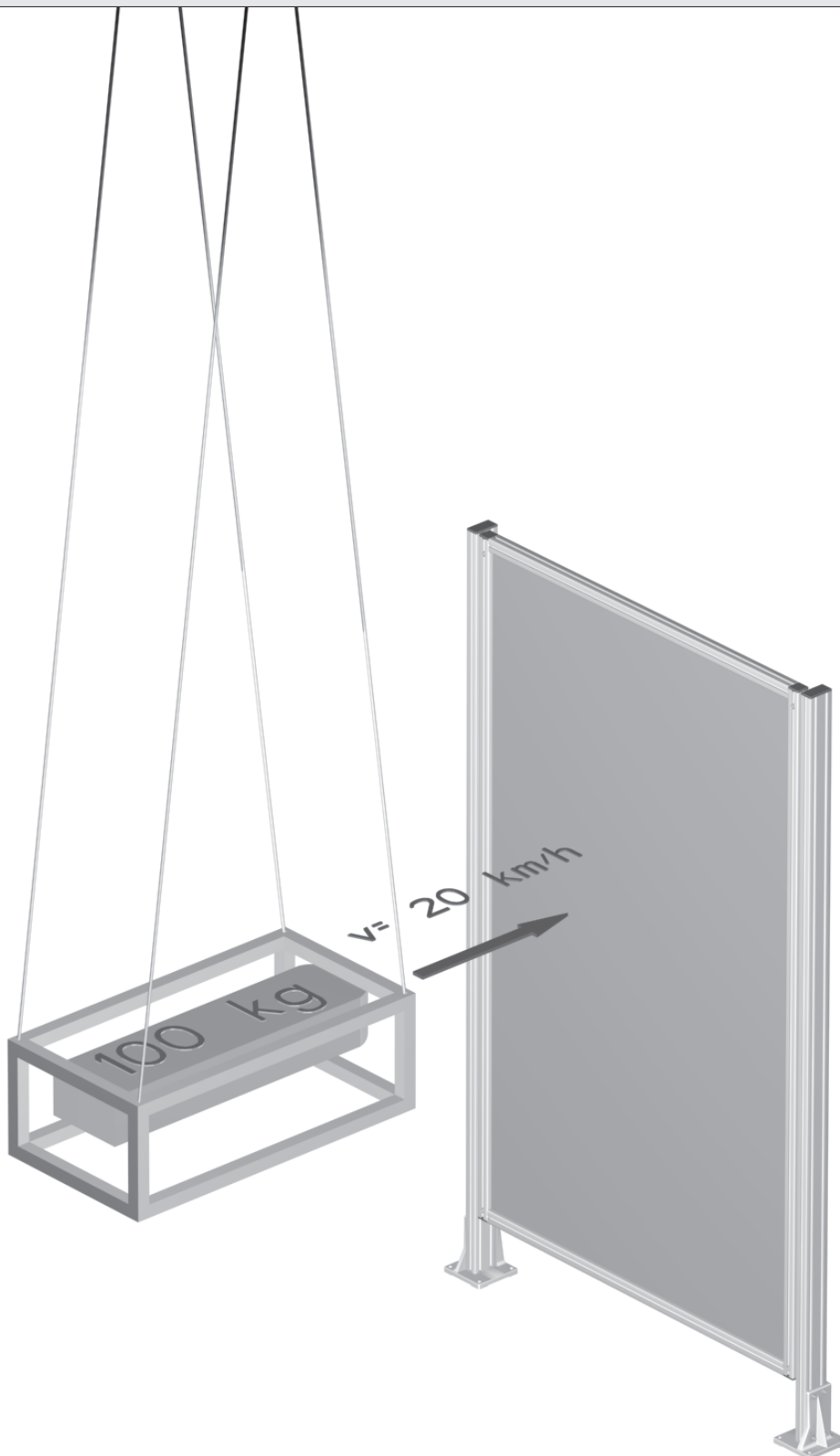
**Test conditions**

During this test a body of 100 kg is accelerated to 20 km/h.  
During impact of the body into the test barrier an energy of 1600 Joule will be released.  
The impact zone is located at the upper third of the test barrier.

Safety barrier unit: without frame

Test with:

Panel element:

Polycarbonate 4 mm

Post:

Panel profile 60×80 mm

Frame:

Panel profile 40×40 mm



before impact



at impact



after impact

**Result**

MayTec safety barrier units succeeded all crash tests without permanent damage.



Safety barrier unit: with frame

Test with:

Panel element:

Polycarbonate 4 mm

Post:

Panel profile 60×80 mm

Frame:

Panel profile 40×40 mm

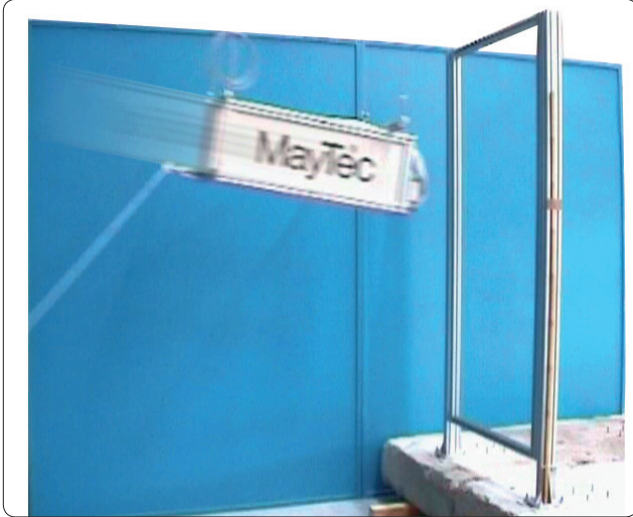

before impact

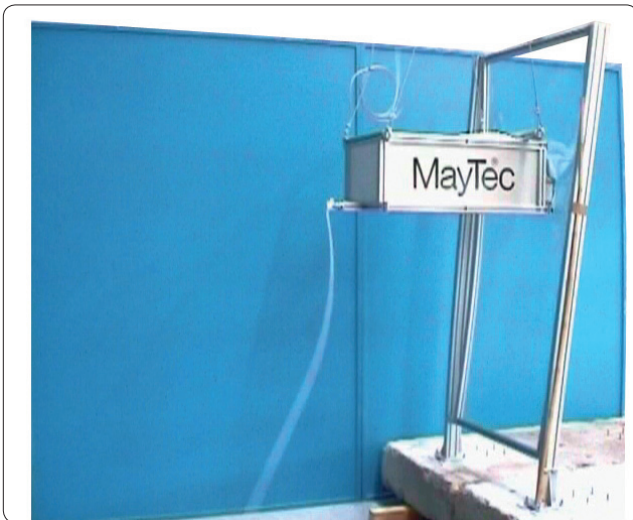

at impact

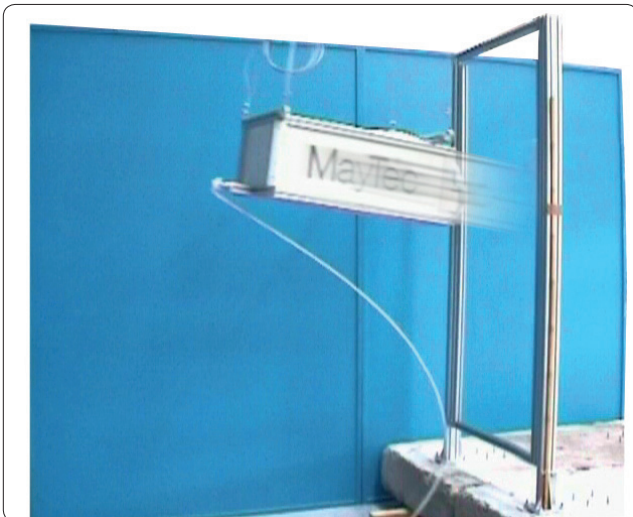

after impact

**Result**

MayTec safety barrier units succeeded all crash tests without permanent damage.



Safety barrier unit: with frame

Test with:	Panel element:	Welded wire net (steel) 4×40×40 mm	
	Post:	Panel profile 60×80 mm	
	Frame	vertical:	Panel profile 40×40 mm
		horizontal:	Wire net profile 30×30 mm



before impact



at impact



after impact

**Result**

MayTec safety barrier units succeeded all crash tests without permanent damage.



**Imprint**

Subject to technical modification.

All rights reserved.

Copying - also in parts - only allowed by written consent.

© MayTec Aluminium Systemtechnik GmbH,  
Germany, D - 85221 Dachau, 2015

The key ...

to success

extremely strong

efficient

functional

### Australia

**MayTec Australia P/L**

Unit 8, 175 James Ruse Drive  
Rosehill, NSW 2142

country code: +61  
phone (0)2/98989929  
fax (0)2/96384086  
e-mail: [info@maytec.com.au](mailto:info@maytec.com.au)  
<http://www.maytec.com.au>

### Germany

**MayTec Aluminium  
Systemtechnik GmbH**  
Kopernikusstraße 20  
D-85221 Dachau

country code: +49  
phone (0)8131/3336-0  
fax (0)8131/3336-119  
e-mail: [mail@maytec.de](mailto:mail@maytec.de)  
<http://www.maytec.de>

### USA

**MayTec Inc.**

901 Wesemann Drive  
West Dundee, IL 60118

country code: +1  
phone 847-429-0321  
fax 847-429-0460  
e-mail: [mail@maytecinc.com](mailto:mail@maytecinc.com)  
<http://www.maytecinc.com>

**MayTec distributor**